

POLAROID AUTOMATIC **220** LAND CAMERA

CONTENTS

Getting Acquainted

	Page
Introduction	4
How to open the camera	5
How to close and cover the camera	6
How to hold the camera	7
How to use the viewfinder	8
How to focus the camera	9
What you should know about your film	10
What the Film Speed Dial does	11
What the Lighting Selector does	12
Practice the 1, 2, 3 system	14

Operation

How to load a film pack	15
How to set the camera for 3000 speed film	18
Tips for good natural light black and white pictures	19
How to set the camera for 75 speed color film	20
Tips for good daylight color pictures	21
How to take a picture	22
How to develop the print	24

If no yellow tab appears	26
Check the temperature! It's important	27
How to make prints lighter or darker	28
Care of the print	29
How to use the Cold-Clip with color film	30
Troublesome lighting situations to avoid	32
Fast focusing for pictures made with 3000 speed film	33
How to use 3000 speed film in dim light without flash	34
Flash pictures	35

Miscellaneous

You must take care of your camera	36
Some helpful accessories	38
Copies and enlargements	39
Picture troubles, their cause and cure	40
Protect film and camera from heat	45
Where to write for information	45
Warranty	45
List of repair stations	46

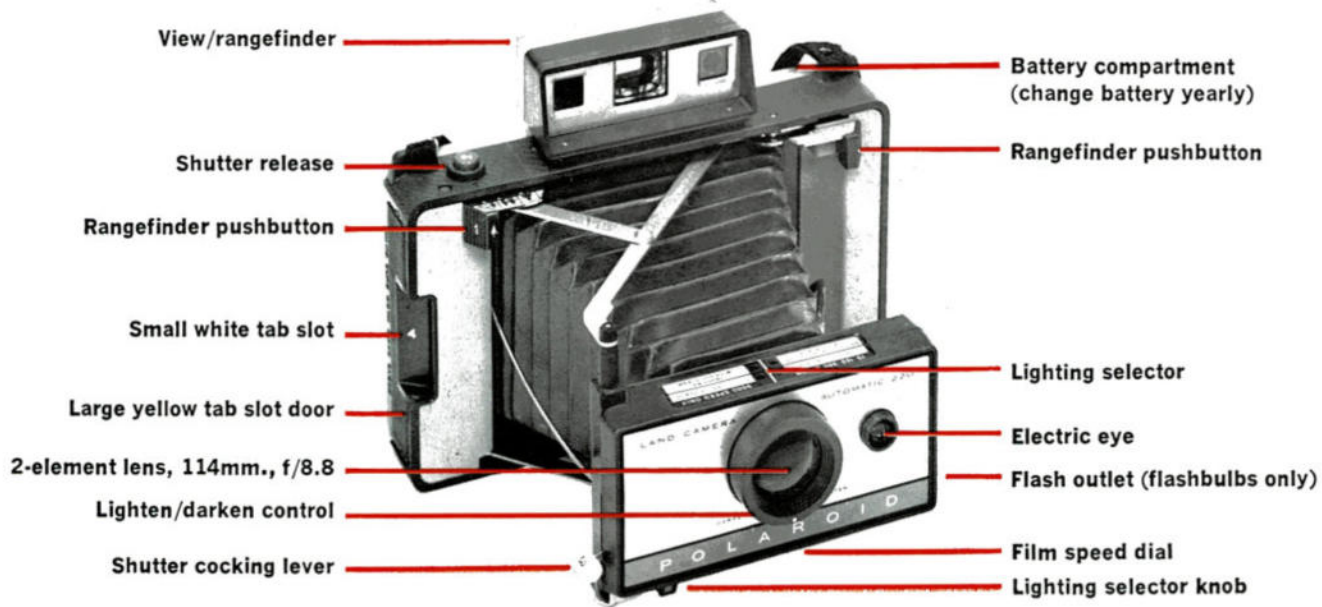

Steel rollers
(Important: keep them clean as described on page 36)

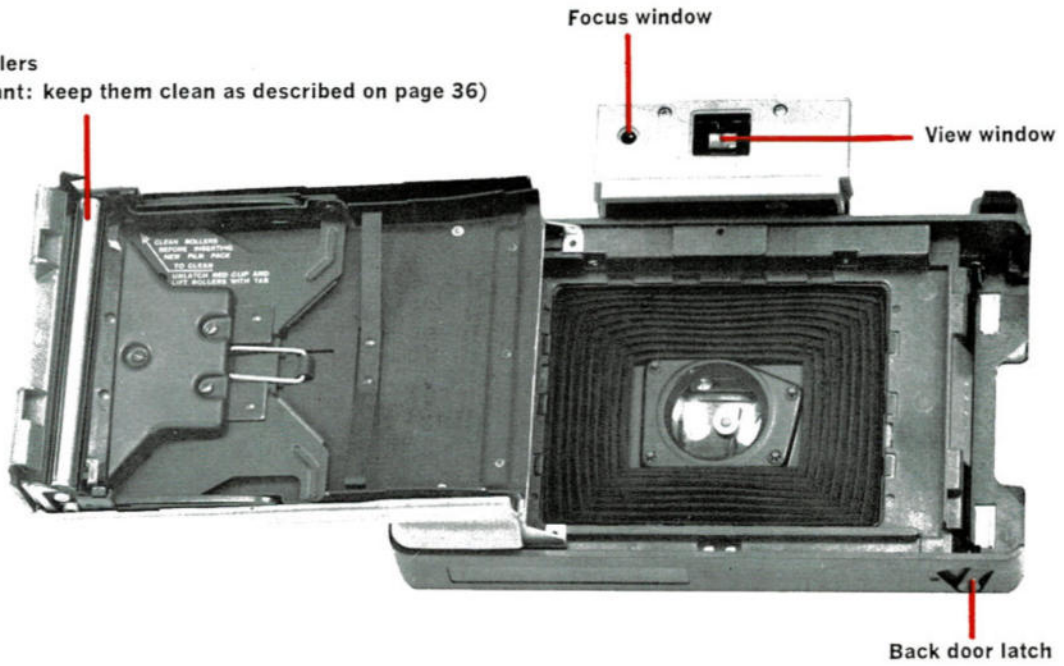

HOW TO GET THE MOST OUT OF THIS CAMERA

Before you load your camera with film, please be sure to read carefully the first two sections in this booklet: Getting Acquainted, and Operation (the pages with colored edges). As you read the text and look at the pictures, go through all the motions of using the camera — without film. Then you'll be completely familiar with it before you make your first picture.

This is one of the world's easiest-to-use cameras, once you understand a few simple techniques. However, it is very important that you learn the basic operating steps or you're bound to waste film and money and be disappointed with your picture results.

Once you get the simple operating routine down pat, load a film pack. We suggest that you start with 3000 speed black and white film. Please remember that even the finest camera and film need some help from the photographer if they are to produce good pictures. That help can be summed up in one sentence:

Plan and think before you shoot.

As a quick guide to help you get a good picture every time, here are some helpful hints. They're important.

1. **Always have the light on the subject coming from behind you.** For best color pictures place your subjects in bright sunshine.
2. **Move in close**, to get a big image in the print.
3. **Focus carefully**, to get sharp pictures.
4. **Choose colorful subjects** for your color pictures.
5. **Pick a good background**, particularly with flash.
6. **Pull the tabs correctly.**
7. **Time development carefully.**
8. **Keep an eye on the temperature.**

As you go through this booklet you'll find these points explained in detail. They can make the difference between getting good pictures and poor ones.

HOW TO OPEN THE CAMERA

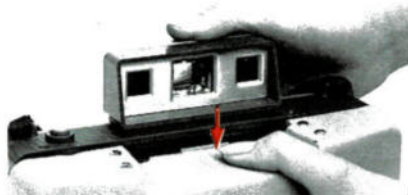

1. To unlatch cover, press on center of top.



2. You can let cover hang down or . . .

GETTING ACQUAINTED



3. . . . to remove it, push spring (A) and lift.

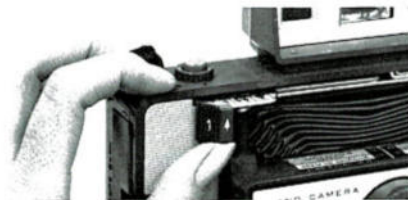

4. Raise button No. 1; this unlocks camera front.

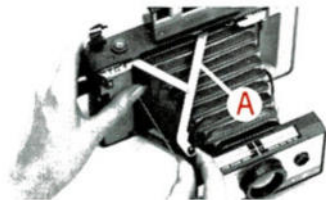

5. Pull camera front out as far as it will go.

PHOTO 5, IMPORTANT: Be sure to pull the camera front out until there is a definite click and the locking bar (A) snaps

into place. If the front isn't fully out and locked, your prints will come out all black, or badly blurred.

This booklet is designed to fit neatly inside the cover, under a spring clip (photo 2).

HOW TO CLOSE AND COVER THE CAMERA

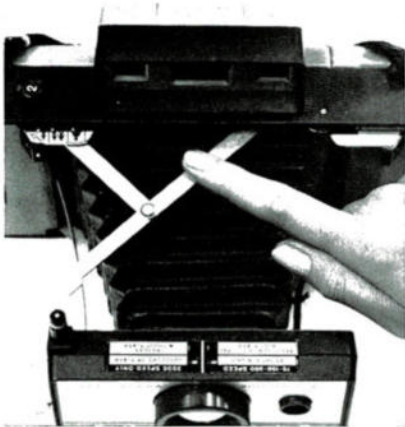

Press down on the locking bar. This releases the front of the camera. Push the front in all the way until it locks.

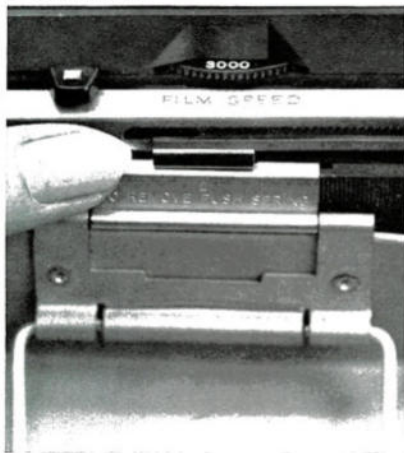

If you have removed the cover: to replace it, slide the hinge down over the lock spring until it snaps into place.



Swing the cover up. Press the top center section under the finder housing so it latches securely.

When storing the camera be sure that nothing presses on the No. 2 button; if it's depressed even slightly, the battery may be drained.

HOW TO HOLD THE CAMERA



HORIZONTAL: Grip the two ends. Place your forefingers on the No. 1 buttons; you can easily shift the right forefinger to the No. 2 button. To steady the camera, press your elbows into your ribs; rest the camera against your nose.

GETTING ACQUAINTED

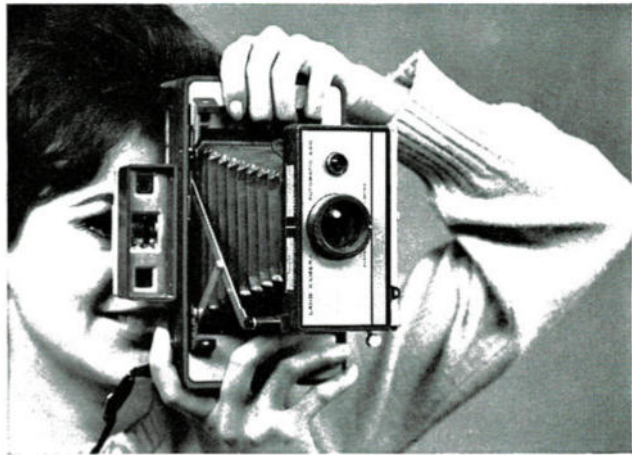

VERTICAL: Grip the camera as you would for a horizontal picture, turn it so your right hand is below. Brace the camera against your forehead and face.

HOW TO USE THE VIEWFINDER

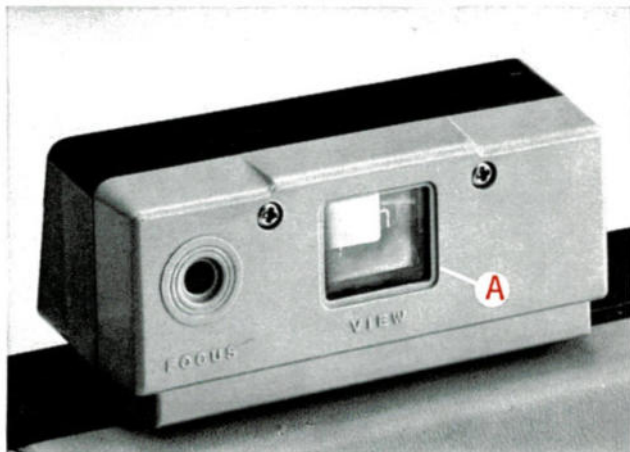

Looking through the viewfinder window (A) you'll see a bright, white broken line. Frame the scene with this line. Always try to look through the center of the window and concentrate on your subject, not on the white line. If your



subject is very close ($3\frac{1}{2}$ ft., for example), allow a little extra space between your subject and the top frame line (above). If not, you may accidentally cut off the top of someone's head in your picture.

HOW TO FOCUS THE CAMERA

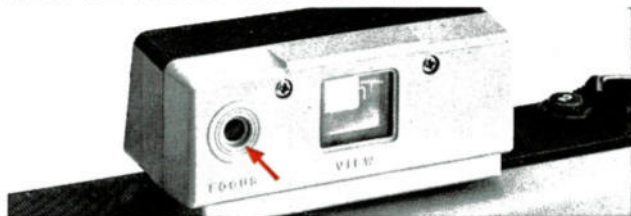

Look through here at the bright spot. ▲ ▼ Push No. 1 buttons.



Holding the camera horizontal, place your forefingers on both No. 1 buttons as shown and push them all the way to your left. Look through the Focus window and aim the bright spot in the center at a nearby subject (about 5 ft. away, for example). You should see two images of your target in

GETTING ACQUAINTED

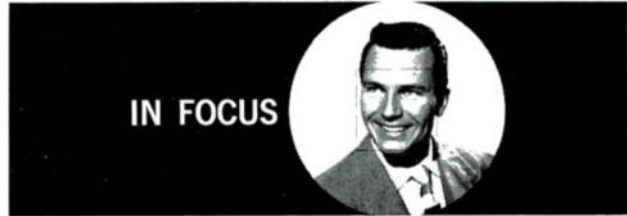
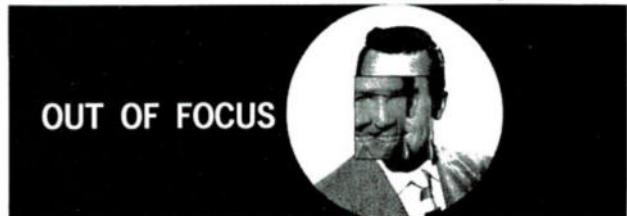

the bright spot; this means that the camera is not focused for that distance. Push the No. 1 buttons back and forth until the two images become one — sharp and clear. Now the camera is focused. For vertical pictures, focus with the camera horizontal; turn it to aim and shoot.

WHAT YOU SHOULD KNOW ABOUT YOUR FILM

This camera uses Polaroid Land pack films. At present there are two: 3000 speed black and white, Type 107, and 75 speed color, Type 108. There may be additional types of film in the future.

You must know the film speed number, 3000 or 75, to set the camera controls correctly (see opposite page). However, if you forget the number, just look at the film instruction sheet.

The film speed number describes how "fast" (light sensitive) the film is. For example, 75 speed film is fairly "fast" but should be used in bright daylight or with flash for good results.

However, 3000 speed black and white is 40X as "fast" as 75 speed color film, so you can make pictures with it where there isn't enough light to use 75 speed film. Of course, you can use 3000 speed film in daylight or with flash, too.

The Polaroid film pack contains all the materials to make eight pictures. For each picture there is a piece of negative film, a sheet of print paper, and a thin foil container (the pod) filled with the jelly-like chemicals needed to develop the picture.

After snapping the picture, you start development by the simple act of pulling a piece of paper out of the camera. This drags the exposed negative, a sheet of print paper, and a pod of chemicals between two steel rollers. The pressure of the rollers squashes the pod, spreading the chemicals between the negative and print paper to form a picture "sandwich".

The picture develops outside the camera. After the recommended development time you separate the sandwich and there is your finished picture.



3000 speed black and white film. Set the camera's film speed dial to 3000.



75 speed color film. Set the film speed dial to 75.

WHAT THE FILM SPEED DIAL DOES



The Film Speed Dial (A) sets the camera for the kind of film you are using. For 3000 speed black and white film turn the dial to 3000; for 75 speed color film turn to 75. If you don't do this, the electric eye (B) can't make a correct expo-

GETTING ACQUAINTED

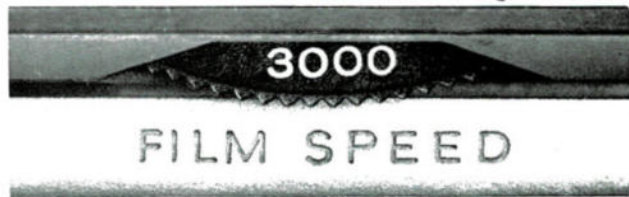

For 3000 speed black and white film. ▲ ▼ For 75 speed color film.



sure. To prevent accidental turning, this dial has a strong spring. It must be turned a rather long way to make it snap to its next position. The other numbers on the dial (besides 75 and 3000) are for films that may be sold in the future.

WHAT THE LIGHTING SELECTOR DOES

You must set the yellow square in the Lighting Selector (shown at right) for the kind of light with which the picture will be taken. For example, sunlight outdoors, or flash indoors, or just room light.

The yellow squares in the Lighting Selector move back and forth when you push the Lighting Selector Knob (below) from side to side. Try it a few times. The knob is on the front of the camera, below the lens.

With 3000 speed film

If there's 3000 speed film in the camera, look at the 3000 SPEED ONLY side of the Lighting Selector and move the yellow square next to the label that describes the lighting conditions. Here it's shown set for OUTDOORS OR FLASH, the right setting for any picture made in daylight or with flash.

For pictures by room light, just push the knob to place the yellow square next to INDOORS WITHOUT FLASH.



With 3000 speed film, use this side of the Lighting Selector.

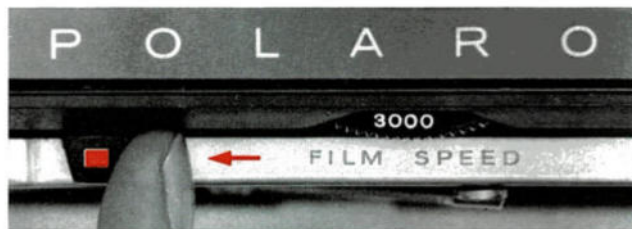

Push the knob to set the yellow square.

With 75 speed color and all other films except 3000 speed

With any film other than 3000 speed film, look at the side of the Lighting Selector marked 75, 150, 300 SPEED. This side is mainly for use with 75 speed color film. The other numbers are for films that may be manufactured in the future.

Use the Lighting Selector Knob to set the yellow square next to the label that describes the lighting conditions.

Remember: You must set the Lighting Selector correctly in order to get a well exposed picture.



With 75 speed color film, use this side of the Lighting Selector.

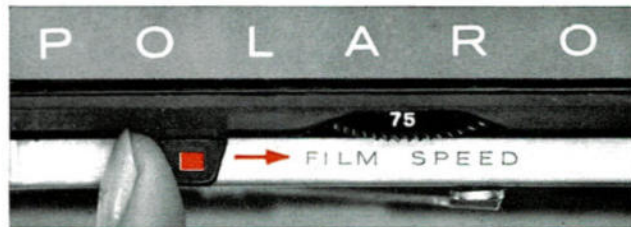

Push the knob to set the yellow square.

PRACTICE THE 1, 2, 3 SYSTEM



ONE is for focusing. Look through the Focus window and aim the bright spot at various subjects. Push the No. 1 buttons and practice bringing together the two images of your subject in the bright spot to make one clear image.



TWO is for shooting. Practice pressing the No. 2 button slowly until the shutter clicks. In dim light hold No. 2 down and stay very still until you hear the second click as the shutter closes. Then you can move and let No. 2 up.

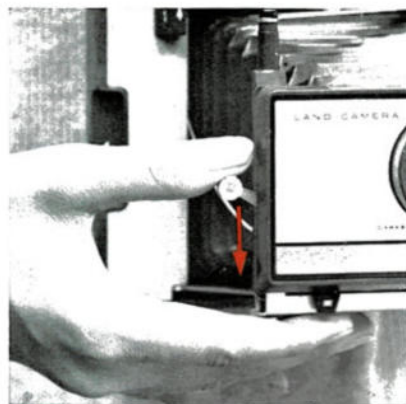

THREE is for resetting. Right after snapping a picture, always push down No. 3 button firmly until it locks and stays down. This resets the shutter for the next picture. If you don't reset No. 3 button, you won't be able to shoot.

HOW TO LOAD A FILM PACK: OPEN THE PACKAGE

OPERATION

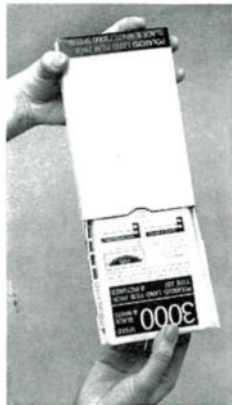

Open the top of the box. With color film there's a set of mounts; with black and white film there's a coater. Remove these and the instruction sheet (please read it). Pull out the film package. Handle it gently, carefully. Save the box to carry prints in safely. It also can be very useful when coating black and white prints.

Hold the package near the edges. **Don't press hard on the**

middle of the package. Starting at the corner, tear open the entire side of the package along the dotted line. When the side is open, rip apart the front and back of the package. Lift out the pack. Discard the moisture absorbing card supplied with color film. Handle the pack by the edges only.

Always open the package and load film in the shade, not in direct sunlight, to avoid fogging the film.

A special request!

As soon as you open the film pack you will begin to accumulate waste paper. There will be more when you develop the pictures. We hope that it won't become litter in the streets or be scattered around the landscape.

What to do with the waste paper? Usually, it will fit into an empty film box. Or, if you're planning to take lots of outdoor pictures, bring along a paper bag or other container for waste. Everyone will appreciate this little extra effort on your part.

HOW TO LOAD A FILM PACK (Cont.)

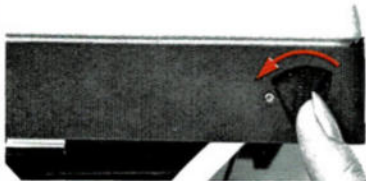

1. Push the back door latch; the door will pop up.

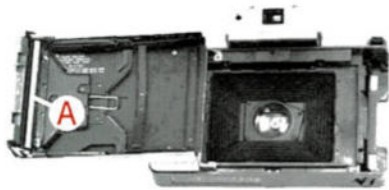

2. Open it all the way. Are the rollers (A) clean? If not, clean them as described in the section on care of your camera.

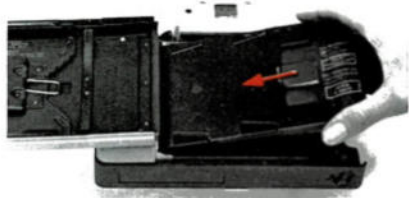

3. Hold the film pack by the edges as shown, and push the closed end of the pack under the door hinge against spring tension.

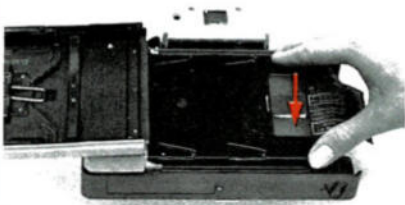

4. Push the pack down into the camera. You'll feel it snap into place.



5. & 6. Check to be sure that the white tabs are not caught between the film pack and the camera body. Close the back door. Press both sides firmly to be sure that both sides latch. The black tab of the safety cover must stick out of the small slot. If not, reopen the back, lead the tab out.

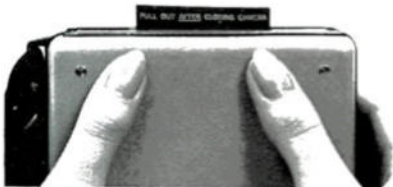



7. & 8. Pull the safety cover all the way out of the camera without stopping. Don't rip it.

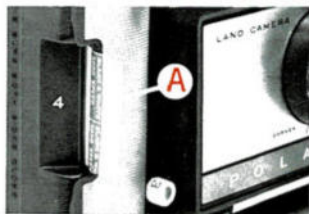

9. With the safety cover out, the white tab (A) should stick out of the small slot (No. 4). Don't pull the white tab. You're now ready for the first picture.

IF NO WHITE TAB APPEARS

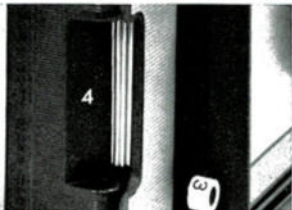

1. If there's no white tab in the No. 4 slot, do the following in the shade or indoors, not in bright sun.



2. Open the back of the camera part way and, without disturbing or moving the film pack, push the white tab out into the open.

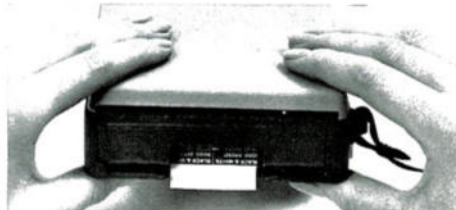

3. Close the back of the camera, making sure that both sides are locked securely and the white tab is outside in the No. 4 slot.

HOW TO SET THE CAMERA FOR 3000 SPEED FILM



Move the knob to set the yellow square for the lighting conditions.

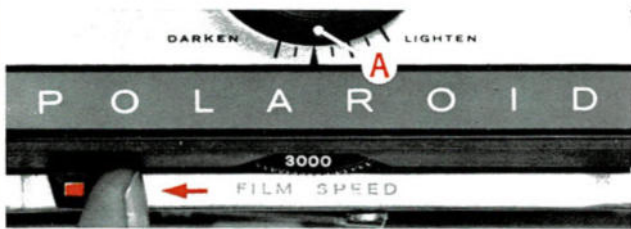

OUTDOORS OR FLASH SETTING: Use this for all subjects in daylight outdoors, in bright sun, in the shade, or on cloudy days. It's also for all flash pictures.

Turn the Film Speed Dial to 3000. Set the dot on the Lighten/Darken control (A) as shown. This is the Normal position for the L/D control.

DIM LIGHT SETTING: Use this for pictures without flash indoors, in dim daylight, and outdoors at night.

Turn the Film Speed Dial to 3000. With light from windows or fluorescents, set the dot on the Lighten/Darken control (A) at Normal position, as shown. With ordinary tungsten bulbs, set it two marks toward Lighten.

OUTDOORS

Use bright, even light, coming from behind you: Place yourself so the light on the subject is coming over your shoulder. Don't have the subject between you and the sun. For portraits you'll get best results when a cloud blocks the direct sun, or on an overcast but bright day, or in open shade. For scenic pictures, avoid high overhead sun.

Watch the background: The light on the background, behind your subject, should be just about as bright as the light on the subject. Don't photograph someone in the shade if the background is out in the open and brightly lit. Strong light behind the subject will "fool" the electric eye (page 32).

INDOORS (with 3000 speed film only)

Have even light coming from behind you: Whether the light is coming from a window or from lamps it should come from behind you or from directly over your head. The electric eye can set correct exposure in quite dim light, if the scene is evenly lit. But if part of the scene is brightly lit and the rest is in shadow you won't get good results.

Don't include windows or lamps: If there's a sunlit window or a strong lamp behind your subject or elsewhere in the scene, this light will "fool" the electric eye (page 32).

Don't move; hold down No. 2: In dim light, exposures may be as long as several seconds. Rest the camera on something steady. Hold No. 2 button down until you hear the shutter click a second time as it closes.

ALL PICTURES

Move in close: The bigger your subject is in the print, the more details you'll be able to see. For scenic pictures, try to get something big and solid looking into the foreground.

Time development carefully: Follow the recommendations in the film instruction sheet. These may change from time to time. With black and white film no harm is done if you overdevelop for a few extra seconds; in fact, it may improve some pictures. However, if you develop for less than the recommended time, your pictures will be of poor quality, with a gray, washed-out look.

Keep an eye on the temperature: Cold weather can affect the quality of your pictures. Be sure to read carefully page 27, which explains how the temperature affects your pictures and what to do about it.

If your picture is too dark or too light: Use the L/D control as shown on page 28 to make the next one of the same subject, in the same location and lighting conditions, come out exactly as you want it to.

HOW TO SET THE CAMERA FOR 75 SPEED COLOR FILM



Set the yellow square as shown for most color pictures.



ALL-PURPOSE SETTING: Use it for practically all your color pictures — in bright sun, in the shade, or on a dull day. Also for flash pictures indoors or for long exposures in dim light. At this setting the lens is at its widest opening and you must focus carefully. Check that the Film Speed Dial is set to 75.



This setting is used only for special situations.

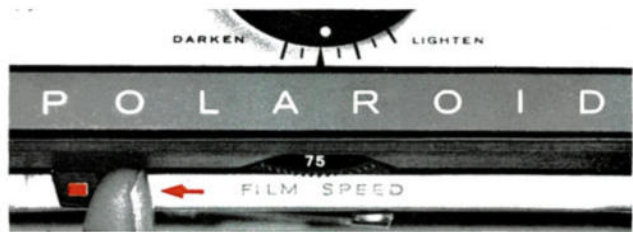

EXTRA DEPTH SETTING: Use it only for subjects in brightest sun, or when you want to add "depth" to your picture by getting more near and far objects into focus at the same time. The lens opening is smaller and the shutter speed slower than at the All-Purpose setting. Check that the Film Speed Dial is set to 75.

Set the L/D control as shown, unless instructions printed on the film pack show a different setting.

Use bright sun, coming from behind you: You'll get strongest colors if your subject is in bright sun (but you can also get pleasing results on an overcast but very bright day). Stand so the light on the subject is coming over your shoulder. Don't have the subject between you and the sun.

Avoid dim light: The shutter moves slowly and your picture may be blurred.

Move in close: The bigger your subject is in the print, the more color and detail you'll see. For scenic pictures, try to have something big and colorful in the foreground.

Focus carefully on the main subject: It will be sharp, but objects much farther or nearer may be fuzzy.

Watch the background: The light on the background should be just about as bright as the light on the subject. Don't photograph someone in the shade if the background is out in the open and brightly lit. The strong light behind the subject will "fool" the electric eye (see page 32).

Have plenty of color: Look for subjects and backgrounds with strong, bright colors in big, solid chunks. If your subject isn't wearing colorful clothes, add color with a bright

shirt, scarf, or jacket. Or, find a colorful background — anything that will fill at least one-third of the picture area with strong, solid color.

Time development carefully: Follow the recommendations in the film instruction sheet. These may change from time to time. Use an accurate timepiece. If you have a Polaroid Development Timer, check it occasionally against a watch with a second hand; if it's fast or slow, allow for this when developing your pictures. A few seconds overdevelopment is not harmful, but prints that are much overdeveloped may look too bluish; those that aren't developed long enough will have a pinkish cast and the colors will be weak.

Keep an eye on the temperature: Cold weather or excessive heat can affect the quality of your pictures. Be sure to read page 27, which explains how the temperature affects your pictures and what to do about it.

If your picture is too dark or too light: Use the L/D control as shown on page 28 to make the next one of the same subject, in the same location and lighting conditions, come out exactly as you want it to.

Never try to use flash with daylight color pictures.

HOW TO TAKE A PICTURE!



FRAME



FOCUS



AIM

1 FOCUS: Look at your subject through the View window. Come close enough to fill most of the frame. Shift your eye to the Focus window. Push the No. 1 buttons

until the bright spot shows a single clear image of the most important part of your subject. Shift your eye back to the View window, center your subject in the white frame.

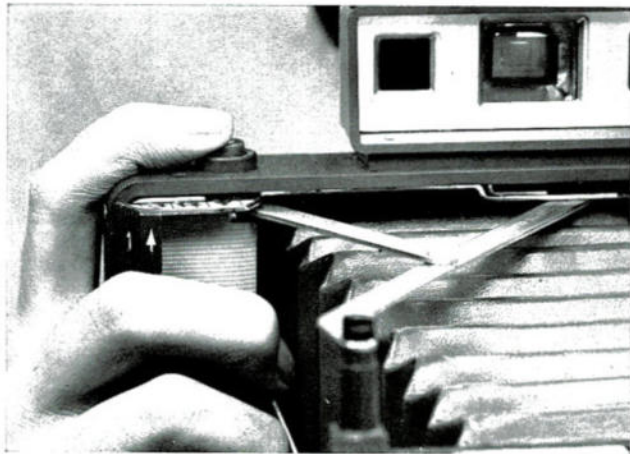

2 SHOOT: Firmly but smoothly press button No. 2, the shutter release, until you hear a loud click. Don't jab at No. 2 — you may shake the camera. When shooting color in the shade or black and white in dim light, hold No. 2 down and don't move until you hear a second click as the shutter closes. Then let No. 2 button come up.

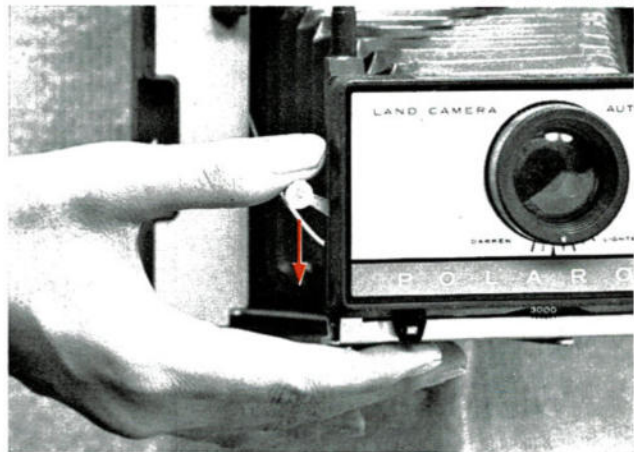

3 RESET: Immediately after snapping a picture, press No. 3 button down firmly until it locks and stays down. This resets the shutter so you'll be ready for the next picture. Always reset No. 3 right away.

HOW TO DEVELOP THE PRINT

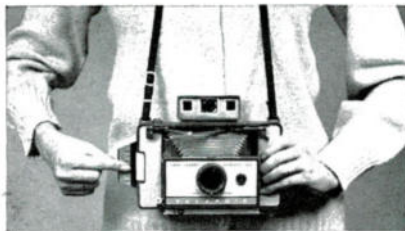
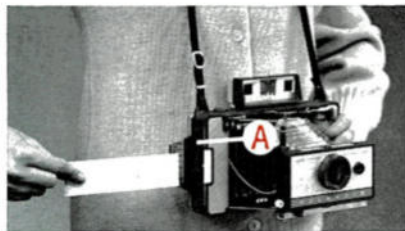
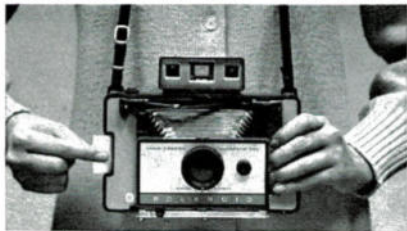

First, the small white tab. Pull it all the way out of the camera. Don't block the door (A).

Next, the large yellow tab.

4 PULL THE TABS: Hold the camera in your left hand, as shown. (**Don't hold it any other way!**) Grasp the small white tab between the thumb and forefinger and pull it straight out of the camera, all the way, without stopping. When you pull the white tab out, a concealed door (A) opens and a yellow tab pops out. Don't block this door in any way while pulling the tabs.

Pulling the small white tab does not start development. It only prepares the film for the next step, which is pulling the yellow tab. Grip the yellow tab in the center so it will come out straight when you pull it out of the camera. If you pull the yellow tab out at an angle, one edge of your picture may not develop properly.

When you pull the yellow tab, hold the camera so the lens faces straight ahead of you, not pointing down. This, plus gripping the center of the tab, helps you to pull it out straight.

Pull the yellow tab straight out of the camera all the way, swiftly, without hesitating. This starts development of your picture, so begin timing as soon as you get the tab out. How fast is a swift pull? It should take about as long as it takes you to say "PULL IT" briskly, each time you pull the tab. If your picture is full of white specks, pull a bit slower.

The picture develops outside the camera. While it's developing, hold the tab by the yellow tip, or lay the picture assembly down flat. Don't touch or bend the white paper or

PULL STRAIGHT, PULL SWIFTLY

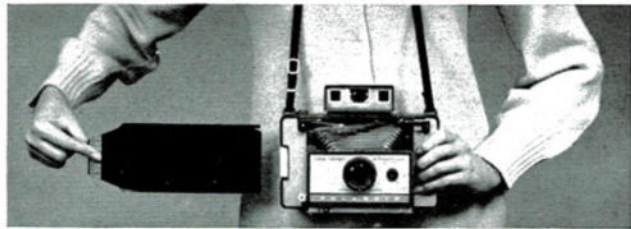

Pull it straight out of the camera, swiftly. Begin timing development.

lift it off. Outdoors, don't let the picture assembly flap in the breeze. Develop the picture for the full time recommended in the film instruction sheet.

After the recommended development time, quickly strip the white print off the brown paper starting from the end nearest to the yellow tab. A color print will look nearly dry, but don't touch the face for a few minutes. It will harden to a tough, glossy finish. When it is dry, mount it on a color print mount, which is supplied with the film.

Don't touch the face of black and white prints. You must coat them to prevent fading and other damage (see page 29 for how to coat prints).

OPERATION



Strip off the white print.



Fold up the negative.

Avoid contact with chemicals left on the negative after the print is removed. (Be sure to read the CAUTION paragraph about this in your film instructions.) Fold up the negative with the moist side in. Please put it in a wastebasket or film box. Don't be a litterbug!

If no yellow tab pops out when you pull the white tab, stop. Don't pull another white tab. Page 26 shows you what to do in this situation.

Never pull a white tab when you can see a yellow tab. If you do so accidentally, don't pull the yellow tabs that appear or you'll spread developer all over the rollers. Instead, remove the yellow tabs as shown on page 26.

Check the temperature! It's important. See page 27.

IF NO YELLOW TAB APPEARS WHEN YOU PULL THE WHITE TAB, STOP!



Don't pull another white tab. Instead, gently open the camera back just enough to get one finger under it to hold down the film pack and keep it in place. Do this indoors or



in the shade. While holding the pack down lightly (picture at left) slowly open the back all the way and take hold of the topmost yellow PULL tab, as shown.

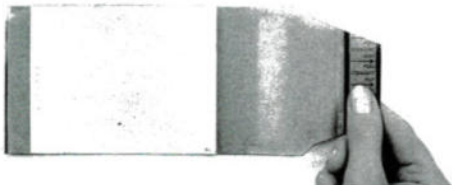
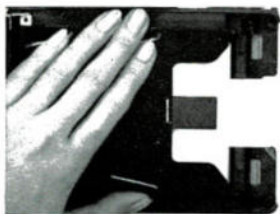

Gently pull the entire picture assembly all the way out of the pack and discard it. Don't try to save it. While the back is open check that the rollers are clean (page 36).

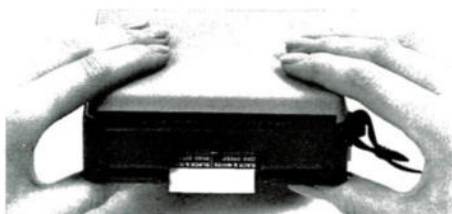

Close the back of the camera, making sure that the next white tab sticks out of the small slot next to No. 4. Check that both sides of the back latch securely.

CHECK THE TEMPERATURE! IT'S IMPORTANT

Cold and heat have a great effect on the way your picture develops and on the print quality. Even moderate cold can ruin your pictures unless you take precautions.

The important factor is the temperature of the camera and film at the time you're developing the picture.

A loaded camera carried outdoors in cold weather for half an hour gets thoroughly chilled. If you then enter a warm house and a few minutes later shoot a flash color picture the results are likely to be bad. It takes a long time for a cold camera and film to warm up.

However, if camera and film are indoors and warm, you can step outside to snap the children in the snow, pop back in again in a minute and develop the picture normally.

In cool weather development times may have to be adjusted according to the temperature. The instruction sheet with each film pack contains detailed information about development times and temperatures. Be sure to read these recommendations; they may change from time to time.

In very hot weather there is a greater tendency for chemicals to be squeezed out of the edges of the picture assembly as you pull the yellow tab to begin development. If these chemicals collect on the steel rollers they can cause defects in your prints. So, when it's hot, be extra careful to keep the rollers clean (page 36).

OPERATION

HOW TEMPERATURE AFFECTS COLOR FILM

The normal development times for color film are set for temperatures of 70°F (21°C) and warmer. When it's a bit cooler the action of the developer chemicals slows down and you must develop for a longer time. See the film instruction sheet for more details.

When the temperature gets to 65°F (18°C) and below, the chemical action is so sluggish that the picture won't develop well without help. That help is the Cold-Clip (page 30). Prints developed in cold weather without using the Cold-Clip will be dark, with muddy colors.

Whenever it's cool enough so that you must wear warm clothes, use the Cold-Clip for all color pictures.

You'll get your best colors in pictures made in pleasantly warm weather.

But when you're sweltering and can think only of a cool drink and a swim, it may be too hot for best results with color film; your prints may show weak colors. For more details, see the film instruction sheet.

HOW TEMPERATURE AFFECTS BLACK AND WHITE FILM

The film's normal range of development times gives good results in temperatures of 60°F (15°C) and above.

When the temperature of film and camera is below 60°F (15°C), develop for a longer-than-normal time. For details see the film instruction sheet.

Never use the Cold-Clip with black and white film.

HOW TO MAKE PRINTS LIGHTER OR DARKER



This is well exposed . . . leave the L/D control here.



If it's too light . . . set the L/D control here.



If it's too dark . . . set the L/D control here.

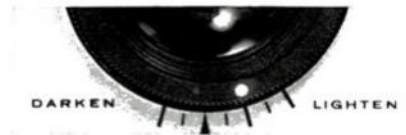
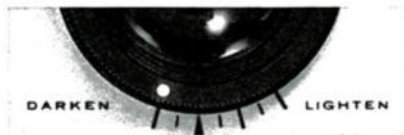
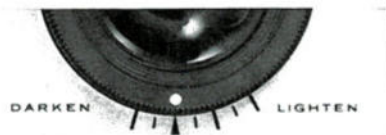

Most pictures made with the light coming from behind you or from the side will be well exposed with the L/D control at Normal position (left, above), but sometimes you may prefer a lighter or darker print. To lighten or darken the next print of the same subject, in the same lighting conditions, adjust the L/D control as shown. To make a small change, turn only

to the first small mark. Use the L/D control in the same way to lighten or darken flash pictures, too. On some color film packs you may find a printed instruction advising you to set the L/D control one mark toward Lighten for all pictures made with that film pack. Please follow those suggestions; they are important.

CARE OF THE PRINT

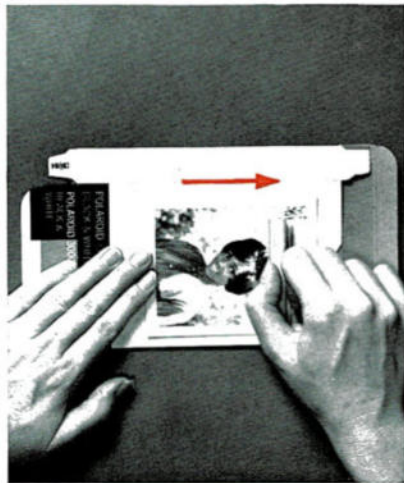

COAT BLACK AND WHITE PRINTS

Black and white prints should be coated within two hours, if possible, to protect them from scratches, finger-

prints and fading. Each black and white film box contains a coater. To coat the print, lay it face up on a clean smooth surface and hold it down by one edge. An empty flattened film box is a good coating surface.

Remove the coater from the tube. Hold it by the plastic handle and run the liquid-soaked side down the length of the picture, away from you. Use 6 to 8 overlapping strokes and moderate pressure. Cover the ENTIRE print, including the borders. Don't scratch the print with the edge of the coater. To get more liquid from a partly used coater, press it down on the near end of the print, then spread the squeezed-out liquid across the picture.

The coating dries quickly and forms a tough protective layer over the image. Don't bend or crease coated pictures, and don't write on the back with a ball-point pen or a sharp pencil; the coating may crack and cause discoloration in the print. When you write on the backs

OPERATION

of prints, use a soft pencil and write lightly, and only in the areas around the edges. Keep freshly coated prints away from each other, or they will stick together.

Don't use corner mounts, paste, glue, or rubber cement to mount pictures. Many adhesives contain impurities that discolor pictures. Never put your pictures in albums with black paper leaves; use Polaroid Picture Albums.

MOUNT COLOR PRINTS

Color prints should be mounted to protect them from curling or from being bent and cracked due to rough handling. Use the Polacolor Print Mounts supplied with each color film pack. **DO NOT COAT COLOR PICTURES.**

The dyes used to form colors in the prints are long lasting. However, like all dyes, they will fade if exposed to bright light for long periods of time. For maximum protection and easy access, store prints in Polaroid Picture Albums.

HOW TO USE THE COLD-CLIP WITH COLOR FILM



The Cold-Clip, which should be stored in your camera cover when not in use, makes it possible to get good color pictures when the temperature is 65°F (18°C) or below. If you are unsure of the temperature, use the Cold-Clip anyway. It may make a noticeable improvement in the color of your pictures and it can do no harm even if the temperature is warm.



To use the Cold-Clip, take it out of the camera cover and preheat it in a warm inside pocket, or between your body and arm, for about five minutes before starting to take pictures.



If the temperature of the camera and film is 65°F (18°C) or below when you develop the picture, using the Cold-Clip, you should expose your color pictures with the L/D control set two marks toward Lighten, as shown here. If the Normal position of the L/D control for that film pack already is one mark toward Lighten, set the L/D control two additional marks toward Lighten for the conditions described above.



As soon as you have pulled the yellow tab to remove the picture packet from the camera and start development, place the packet inside the Cold-Clip with the tab hanging out. This must be done within 10 seconds.



Put the Cold-Clip, with the picture assembly inside, between your body and arm while the picture develops.



Develop the picture for 60 seconds inside the Cold-Clip, then remove the packet and separate the picture.

Occasionally, developer may leak from the picture assembly and stick to the Cold-Clip. Avoid contact with this material. (Please read the CAUTION paragraph in your film instructions.) Before using the Cold-Clip, wipe it clean with a damp cloth.

Never use the Cold-Clip for black and white pictures. Instead, follow the cold weather directions on the instruction sheet packed with each box of film.

TROUBLESOME LIGHTING SITUATIONS TO AVOID



Face in shade, bright sun behind.



Bright window behind or near subject.



Bright lamp behind or near subject.

When you aim your camera at a subject, the electric eye measures the brightness of the entire scene and sets the exposure for what it "sees" there. As long as the light on the main subject is just about as bright as the light on the rest of the scene, the picture will be well exposed.

However, if most of the light comes from behind your subject, or if the light is brighter behind your subject than in front, or if there's a strong light in the scene, the electric eye will be "fooled" and your picture will come out too dark.

That's what happened in the three picture situations shown above. The subject's face is in the shade or in a fairly dim light, but either the background is bright or there's a strong light in the scene.

Try to avoid these troublesome lighting conditions. If you have to shoot a shaded subject against a bright background or a strong light, turn the L/D control all the way to Lighten.

To beat this problem, arrange your subjects so the light on them comes from behind you or from the side.

FAST FOCUSING FOR PICTURES MADE WITH 3000 SPEED FILM



Portraits, up close, 3½ to 5 ft. . . .
set the scale here ▼

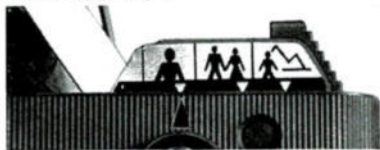

If there's 3000 speed black and white film in the camera and you're shooting outdoors in daylight or indoors with flash, it's not always necessary to use the rangefinder in order to get sharp pictures. Just push the No. 1 buttons to preset the Fast Focus Scale (bottom) for the kind of subject you are snapping. Then frame your subject in the view-



Groups, other subjects 5 to 10 ft. away . . .
use this setting ▼



finder and shoot. The Fast Focus Scale is handy for snapping children, pets, etc. in action nearby, or for getting both near and distant subjects sharp in the same picture (top, right).

Use the Fast Focus Scale only with 3000 speed black and white film in bright sunshine or with direct flash. Don't use it in dim light, with bounce flash, or with color film at any time.

OPERATION



Scenics, everything beyond 10 ft. . . .
set the scale like this ▼



HOW TO USE 3000 SPEED FILM IN DIM LIGHT WITHOUT FLASH

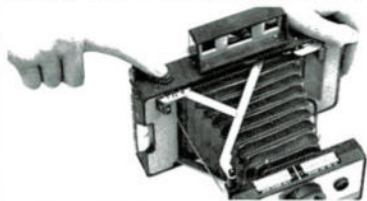

Set the camera on a solid surface, press the back of it down firmly to prevent movement.



Brace it against a wall or door.



Rest your elbows on something.

If there's enough light to read comfortably, you can use 3000 speed film to make good black and white pictures indoors (or outdoors) without flash. Set the yellow square in the Lighting Selector to **INDOORS WITHOUT FLASH** and the L/D control as shown above. The shutter will move slowly, so the camera must be rock steady or your pictures will be

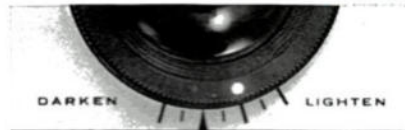

L A R O
For subjects lit by ordinary household lamps (tungsten bulbs) set the L/D control here.

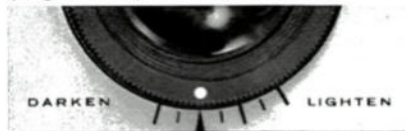

L A R O
For window light or fluorescents, set it here.

blurred. Try to place your subjects so the light on them is even. Don't include bright lamps or windows in your picture or it will come out too dark. In very dim light the electric eye will make a time exposure, which may be as long as several seconds. Hold No. 2 button down and don't move until you hear the second click as the shutter closes.

Many of your most interesting and appealing pictures will be made indoors with flash. Flash pictures are easy to make with your camera and with a little practice you will be able to snap them as simply as you snap pictures in the sunshine.

The Polaroid flashgun clips to the camera and fires when you press the No. 2 button. You just focus the camera on your subject; the camera then sets the exposure for you automatically. Whether you stand 6 ft. from your subject, or move in to 4 ft., or back up to 8 ft., the picture will be well exposed.

Complete instructions for making flash pictures are packed with each flashgun. Your camera dealer will be glad to demonstrate the flashgun for you.

YOU MUST TAKE CARE OF YOUR CAMERA

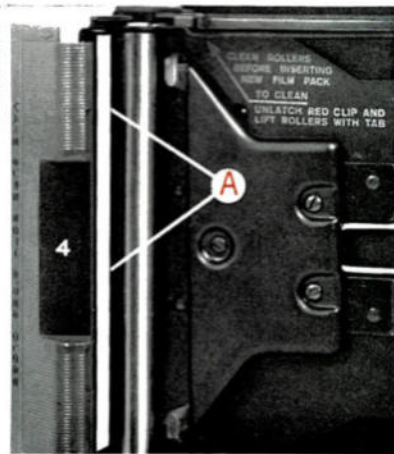
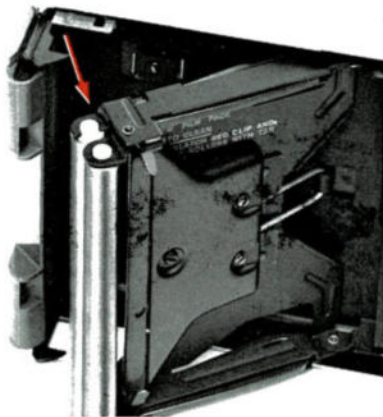
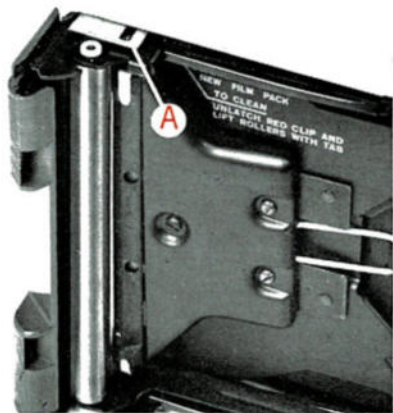

KEEP THE ROLLERS CLEAN: Dirt on rollers can cause repeated spots on the print and poor colors. It can even prevent the yellow tab from popping out. Bits of developer can collect on the rollers, particularly at the ends, and in the back of the camera. Inspect the rollers before loading. Lift up the red latch (A, left). Swing out the rollers; turn and inspect

them, especially at the ends. Wipe the rollers clean with a damp cloth, dry them. Never scrape them with anything metallic, nor with your fingernail. Open the tab slot door; clean out any dirt around the tab slot (A, right). Blow out lint or dust in the back of the camera. Push the roller assembly back into place.

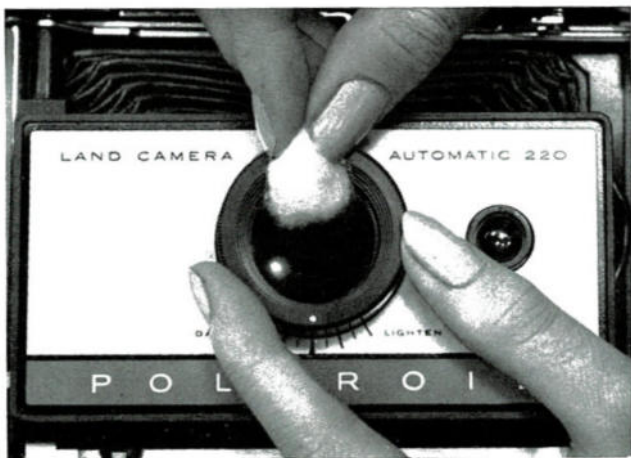

CLEAN THE LENS GENTLY: Never use silicone coated eye-glass tissue on it. Blow dust off or brush it off lightly. Breathe gently on the lens to moisten it, wipe lightly with clean, dry, absorbent cotton. Also clean the lens over the electric eye.

REPLACE THE BATTERY EVERY YEAR: The battery powers

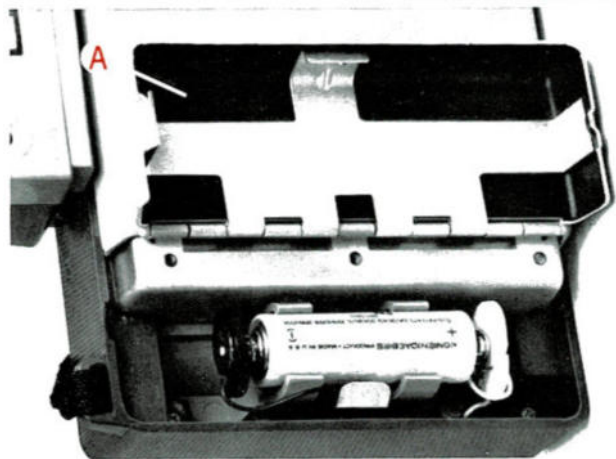

the electric eye and shutter controls. If it's weak you'll get all-black prints. Use a fingernail to open the compartment door (A) in the back of the camera. Install a new battery of the same or equivalent type, in the same position as the old one. See your Polaroid Land camera dealer for replacements.

SOME HELPFUL ACCESSORIES



Cable release #191, with plastic adapter, fits over No. 2 button. Great for time exposures.



Cases #324, #322, #326 and #325 hold camera, spare film packs, flashgun, bulbs, other accessories.



Development Timer #128 fits on camera strap times development of your pictures.



Self-timer #192 fits over No. 2 button, lets you get into your own pictures.



Picture Album #519 holds 72 black and white or mounted color prints in jackets.

These simple accessories can add much to your picture-taking pleasure. See your Polaroid camera dealer.

COPIES AND ENLARGEMENTS

It's easy to get copies and enlargements, both in color and black and white. Just use the form packed with your film or camera to order them from Polaroid Copy Service.

The reproductions are sharp, clear, and remarkably faithful to your original Polaroid picture. Copies are available in either the popular 3¼ x 4¼ in. size or the 2½ x 3¼ in. wallet size. Beautiful mounted enlargements can be made in 5 x 7 in. or 8 x 10 in. sizes. They make handsome gifts for birthdays or anniversaries. You can also order holiday greeting cards featuring your favorite Polaroid Land picture. Service is prompt and as convenient as your mailbox.



PICTURE TROUBLES, THEIR CAUSE AND CURE



WHITE, FAINT IMAGE OR NONE

Film was greatly overexposed or light-struck. If it happens with 3000 speed black and white film, you probably had the Film Speed Dial set to 75. Reset it to 3000. Both color and black and white films will be light-struck if you pull out the safety cover before putting the film pack in the camera or if you remove a film pack from the camera after pulling the safety cover.

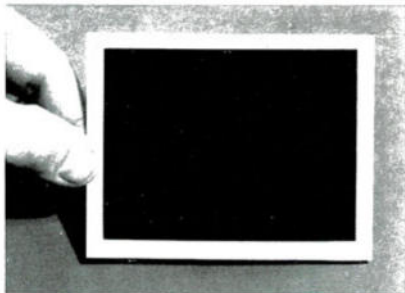

BLACK, FAINT IMAGE OR NONE

If no details at all are visible, the shutter didn't open. Perhaps you didn't reset No. 3 button. Or, the front of the camera wasn't pulled out all the way and locked. Or, the camera battery is dead. Or, the shutter has been damaged.

If a color print shows a few faint details, the Film Speed Dial probably was set to 3000. Reset it to 75.



MANY WHITE SPECKS

They are a sign that you pulled the yellow tab too swiftly; slow down a bit.



TOO DARK: ALL PICTURES

Probably the L/D control was set incorrectly. For pictures outdoors or by direct flash, set it to Normal. If that's where it was to begin with, turn it toward Lighten. For pictures in dim light, set it as shown on page 34.

Daylight pictures will be badly exposed if the flashgun is plugged in. Check that the flashgun is not plugged in when making daylight pictures.



TOO LIGHT: ALL PICTURES

Overexposed, probably because the L/D control was set incorrectly. For most pictures, set it to Normal position. If that's where it was to begin with, turn it toward Darken.

MISCELLANEOUS



U-SHAPED WHITE AREA

Several possible causes: One or more white tabs were folded under when you loaded the film pack (correct this as shown on page 17, bottom). Or, you pulled the yellow tab too slowly (page 25). Or, there may be dirt on the ends of the rollers; keep them clean (page 36). Or, in some way you squeezed the tab slot end of the camera back while pulling the yellow tab (see page 24 for the correct way to hold the camera).

PICTURE TROUBLES (Cont.)



REPEATED WHITE SPOTS

Marks like these show that the steel rollers are dirty. Inspect and clean them frequently (page 36).



MUDDY LOOKING PRINT

It wasn't developed long enough. Develop both black and white and color prints for the full time recommended in the film instruction sheet. See page 30 for details of how to use the Cold-Clip with color prints. If you don't develop long enough, color prints will be brownish pink over-all; black and whites will be muddy gray.



SUBJECT FUZZY, REST SHARP

If the subject didn't move but is unsharp you didn't focus carefully. Check page 9 to be sure that you are focusing in the proper manner.



UNDEVELOPED EDGES OR CORNERS

Picture flaws such as this one are usually caused by pulling the yellow tab out at an angle. In this example the tab was pulled down, instead of straight. When this happens the developer is not spread evenly over the picture and edges and corners may not develop. Pull the yellow tab out straight and swiftly, all the way (pages 24, 25).



ORANGE-RED MARKS ALONG EDGE

Reddish-orange marks like these (A) along the edge and/or in the corners of the print generally indicate that the yellow tab was pulled out of the camera at an angle. Pull the yellow tab out straight and swiftly, all the way (pages 24, 25).

MISCELLANEOUS



OBLONG IN PRINT

The oblong is pink or red in a color picture. You didn't pull the white tab all the way out of the camera. As a result, when you pulled the yellow tab, the white tab was dragged back into the camera and spoiled the picture.

Always pull the white tab right out of the camera (page 24).

PICTURE TROUBLES (Cont.)



STREAMERS OF LIGHT

You made a flash color picture with the Lighting Selector set to BRIGHT SUN ONLY, instead of ALSO FLASH. At this small lens opening there was not enough light from the flash so the electric eye also made a time exposure during which you or the lights moved. Or, with the correct setting you were too far from the subject, the flash was too weak and the electric eye also made a time exposure.



CORNERS, EDGES VERY DARK

This happens mainly with 3000 speed black and white film and only with subjects in the bright sun. Caused by having the Lighting Selector set to INDOORS WITHOUT FLASH when it should be set to OUTDOORS OR FLASH (page 18).

It may also occur, to a lesser degree, with color in very bright sun. If so, shift the yellow square in the Lighting Selector to BRIGHT SUN ONLY (page 20).



UNDEVELOPED AREAS IN PRINT

It may be a single blank white area or a combination of blank areas and streaks (orange in color pictures) as shown. You pulled two or more white tabs before pulling a yellow tab, causing: uneven spread of developer; jammed film; or developer smeared on rollers. Always inspect and clean the rollers before taking more pictures.

If no yellow tab appears when you pull a white tab, never pull another white tab. Follow the directions on page 26.

PROTECT FILM AND CAMERA FROM HEAT

Extreme heat and high humidity can damage your films, especially after the film pack has been placed in the camera. Don't leave a loaded camera or packages of film lying in direct sun. Remember that the glove or luggage compartment of a car can get as hot as an oven. If you store film or a loaded camera in a closet, keep it near the bottom where the air is cooler. Don't remove a film pack from its sealed foil inner wrapping until you are ready to use it.

FOR MORE INFORMATION

If you have any questions about the operation and performance of the camera, films and accessories that are not answered here, see your dealer. Or, write to the nearest Polaroid office (see next page for addresses). Send picture samples with full details of your difficulties and please be sure to include a clearly printed or typed return address.

WARRANTY

If, through any human or machine error at time of manufacture, any part or workmanship in this camera proves defective, we will repair it at no charge providing the camera is shipped by prepaid transportation to one of the authorized

repair stations listed on the next page. This guarantee covers the camera for one year from date of original purchase.

The guarantee does not cover (and charges will be made for) batteries or repairs required to correct damage from battery leakage, accident, dropping, mishandling, wear and tear, or rough or heavy use. Only authorized repair stations have the properly-trained staff, and the approved tools, testing equipment and parts to repair these cameras. No reimbursement can be made for repair charges made by non-authorized repair stations. Tampering with the camera, or having it repaired by a non-authorized repair shop, voids the guarantee and charges will be made for any subsequent work that may be required.

No liability is assumed for film or flashbulbs which may be spoiled by a camera failure. Any operating difficulty should be reported at once to prevent needless film waste.

If it becomes necessary to return your camera for repair, your dealer can do so for you, or you may ship it direct to the station located nearest to you. Pack the camera carefully in its original protective box for safe travel, and mail it by prepaid INSURED parcel post. Enclose a note describing the reason for the return and/or pictures illustrating the problem.

If the problem concerns flash pictures, be sure to return the flashgun with the camera and in the same package.

POLAROID REPAIR STATIONS AND OFFICES

U.S.A.

Polaroid Corporation
Cambridge
Massachusetts 02139

AUSTRALIA

Polaroid Australia Pty., Limited
11 Smail Street
Ultimo, N.S.W.

BELGIUM

Polaroid (Belgium) S.A.
12-16 rue de la Victoire
Brussels 6

CANADA

Polaroid Corp. of Canada, Ltd.
350 Carlingview Drive
Rexdale, Ontario

Western Camera Service Ltd.*
1855 W. 4th Avenue
Vancouver 9, B.C.

ENGLAND

Polaroid (U.K.) Ltd.
Office, Rosanne House
Welwyn Garden City
Hertfordshire

Repairs, Huggins Lane
Welham Green, near Hatfield
Hertfordshire

FRANCE

Polaroid (France) S.A.
118 rue des Champarons
92 Colombes

GERMANY

Polaroid GMBH
Königslacher Strasse 15-21
6 Frankfurt/Main-Niederrad 1

ITALY

Polaroid (Italia) S.p.A.
Via dei Cignoli 9
20151 Milan

JAPAN

Nippon Polaroid Kabushiki
Kaisha
Mori Bldg. No. 6
32, Nishikubo Tomoe-cho
Shiba, Minato-ku
Tokyo

THE NETHERLANDS

Polaroid (Nederland) N.V.
Haspelsstraat 2
P.O. Box 8047
Amsterdam — Slotermeer

SWITZERLAND

Polaroid A.G.
Hardturmstrasse 175
Zurich 8037

*Independent service facility

FILMS AND ACCESSORIES FOR MODEL 220

ALL-PURPOSE FILMS

Polacolor®, 75 speed color	Type 108
3000 speed black & white	Type 107

ACCESSORIES

FLASHGUN	#268
Use only M-3 clear, not blue bulbs	
DEVELOPMENT TIMER	#128
Accurate timing improves color pictures	

SELF-TIMER #192

Lets you get into your own pictures

CABLE RELEASE #191

For dim light pictures; reduces camera shake

COLD-CLIP #193

Must use with color film in cool weather

PICTURE ALBUM #519, #521

To safely store, quickly show 72 pictures

CARRYING CASES #322, #324,

For camera, film, accessories, etc. #325, #326

1 FOCUS

Look through Focus window. Aim bright spot at subject. Push No. 1 buttons back and forth until two images in bright spot become one.

4 PULL TABS

Pull small white tab straight out of camera, all the way; large yellow tab will pop out. Pull yellow tab straight out of camera, all the way, moderately fast, smoothly, without hesitation. THIS STARTS DEVELOPMENT. Develop for full time recommended in film instruction sheet. Separate white print from brown paper. Don't touch face of print until thoroughly dry.

2

SHOOT Gently press No. 2 button until shutter clicks. In dim light hold No. 2 down, hold steady until second click as shutter closes.



3

RESET Press No. 3 button down until it locks and stays down.